

PS66 - wood

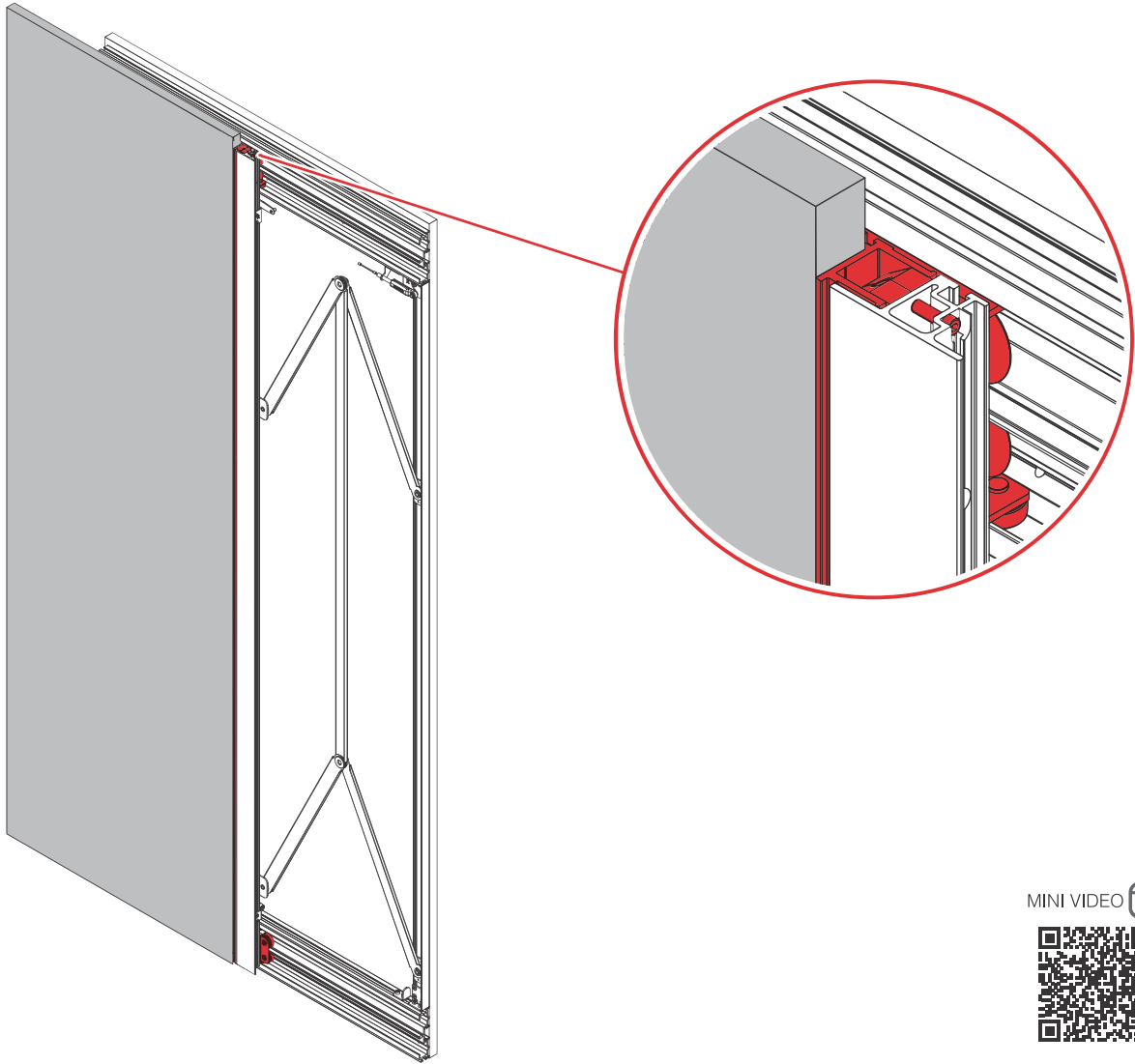

MINI VIDEO 

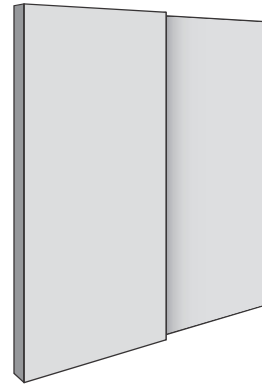

■ page 20

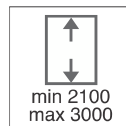
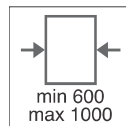
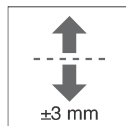
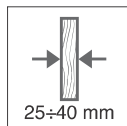
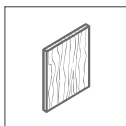

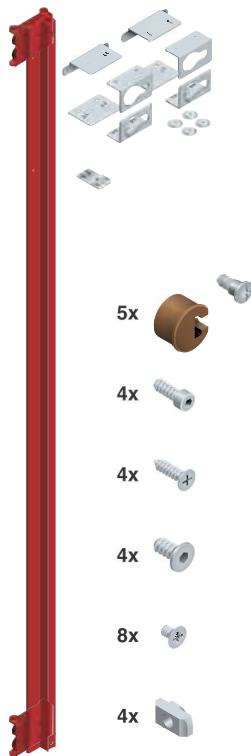
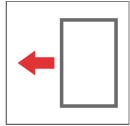

- 5x
- 4x
- 4x
- 4x
- 8x
- 4x



Confezione di montaggio per anta destra in legno Right wooden door assembly kit		
H =	2100 ÷ 2400	PS66PDLE70000001
H =	2400 ÷ 2700	PS66PDLE70000002
H =	2700 ÷ 3000	PS66PDLE70000003

Meccanismo per anta destra Mechanism for right door		
H =	2100 ÷ 2400	PS66MDSM70000001
H =	2400 ÷ 2700	PS66MDSM70000002
H =	2700 ÷ 3000	PS66MDSM70000003

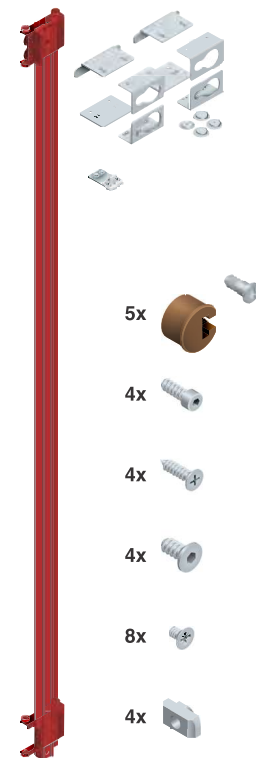
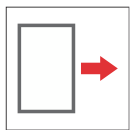

- 5x
- 4x
- 4x
- 4x
- 8x
- 4x

Meccanismo per anta sinistra Mechanism for left door		
H =	2100 ÷ 2400	PS66MSSM70000001
H =	2400 ÷ 2700	PS66MSSM70000002
H =	2700 ÷ 3000	PS66MSSM70000003

Confezione di montaggio per anta sinistra in legno Left wooden door assembly kit		
H =	2100 ÷ 2400	PS66PSLE70000001
H =	2400 ÷ 2700	PS66PSLE70000002
H =	2700 ÷ 3000	PS66PSLE70000003

PS66 - wood

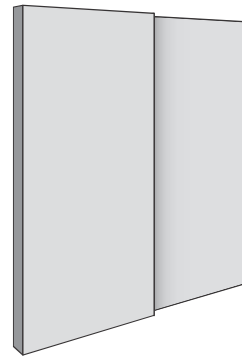
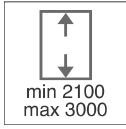

1

R

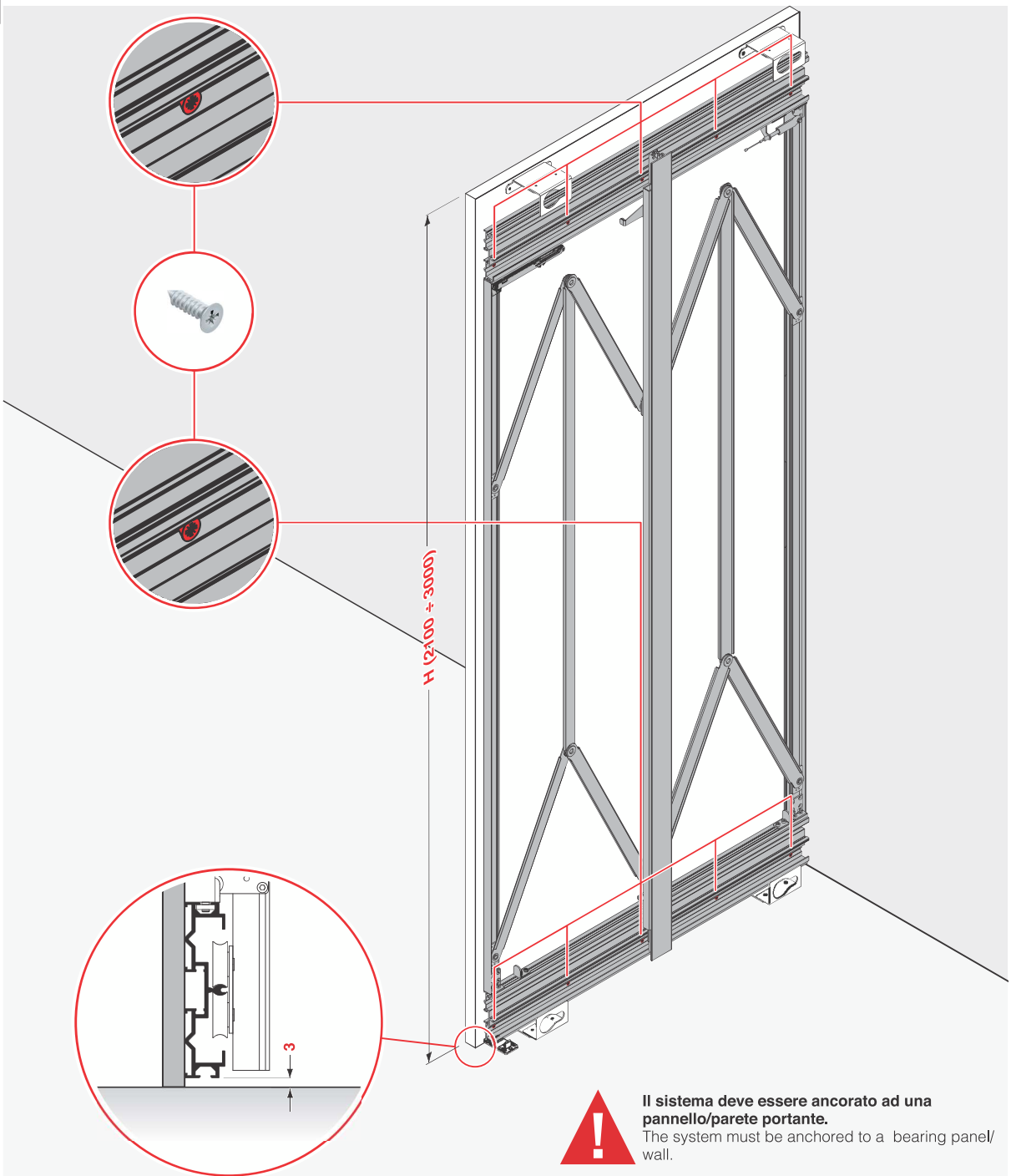
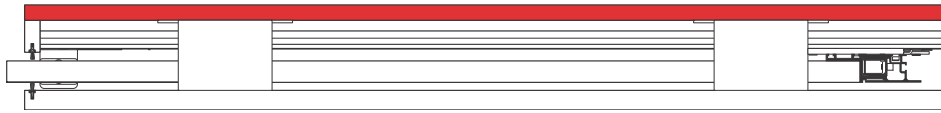

Il sistema deve essere ancorato ad una pannello/parete portante.
The system must be anchored to a bearing panel/wall.

R

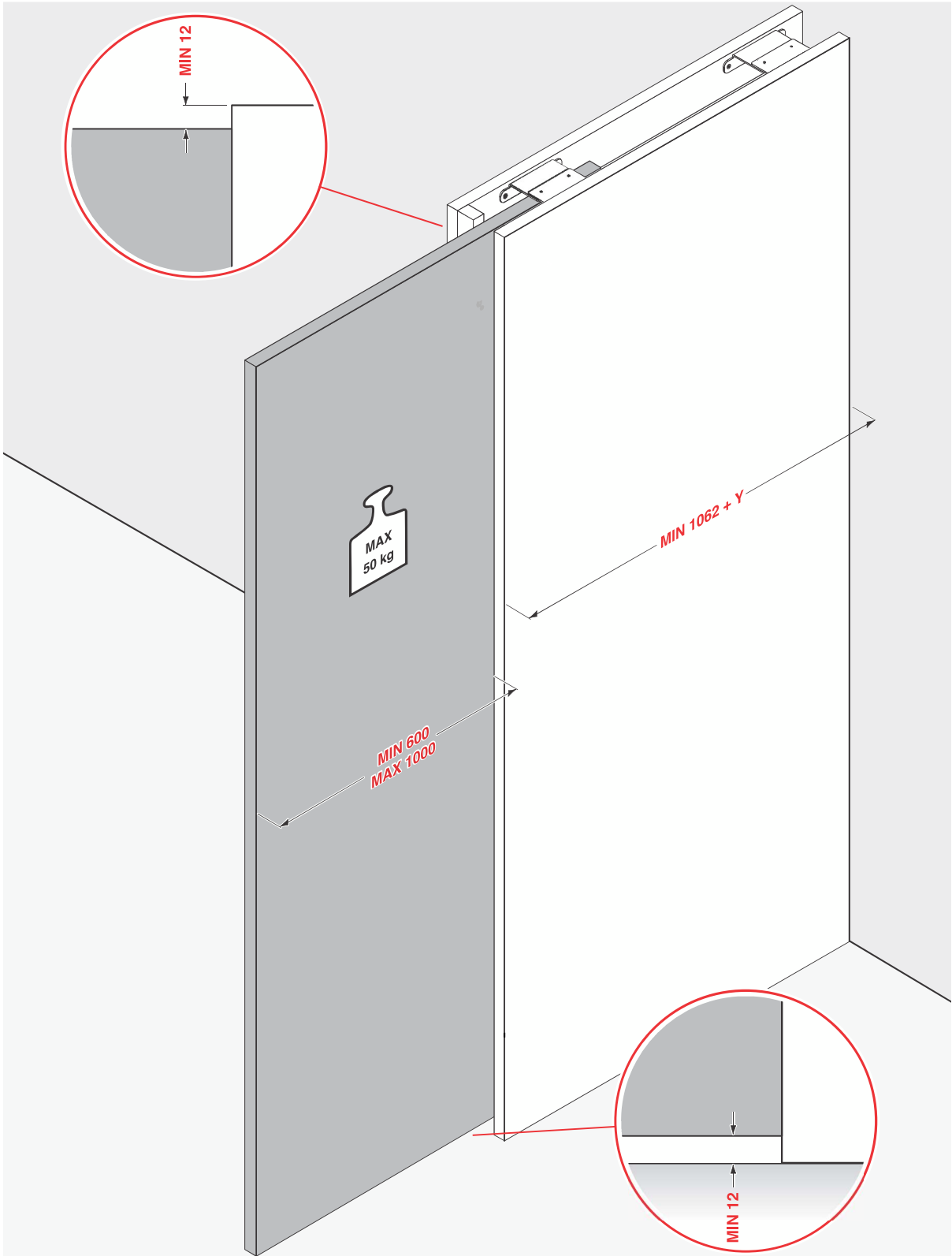

3

R

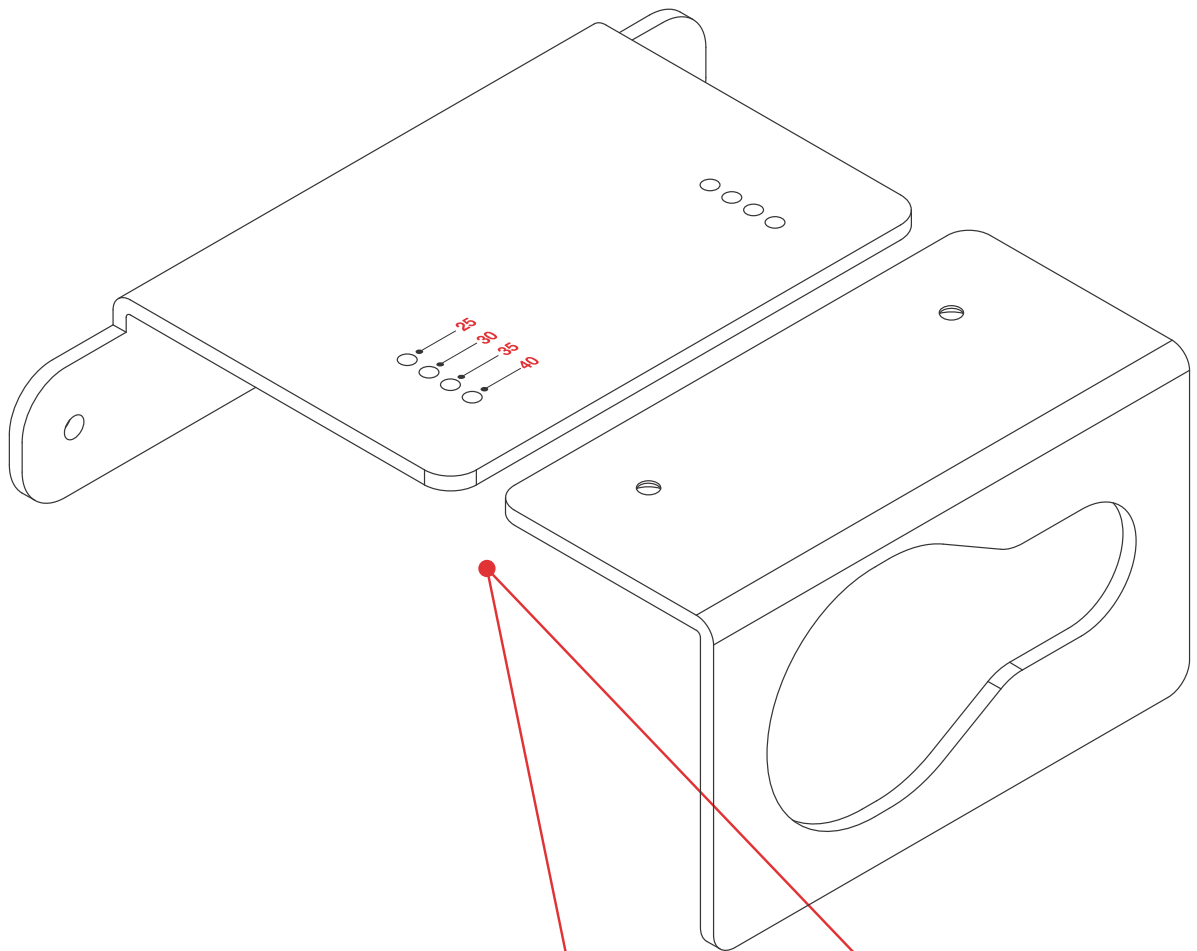

DT = 25	T = 83
DT = 26 ≥ 30	T = 88
DT = 31 ≥ 35	T = 93
DT = 36 ≥ 40	T = 98

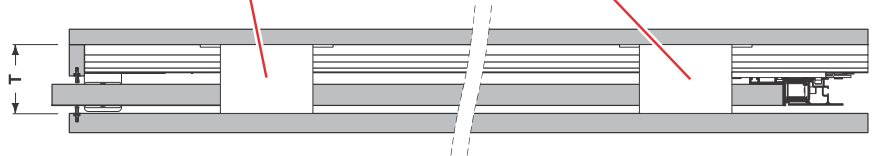

4

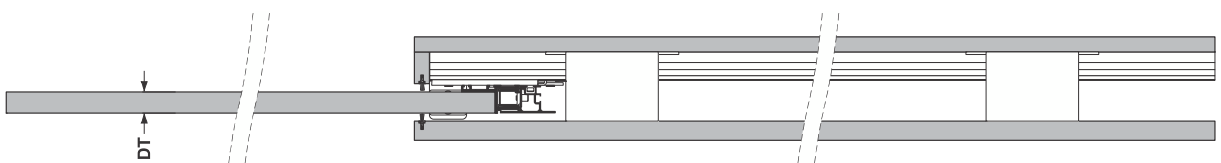

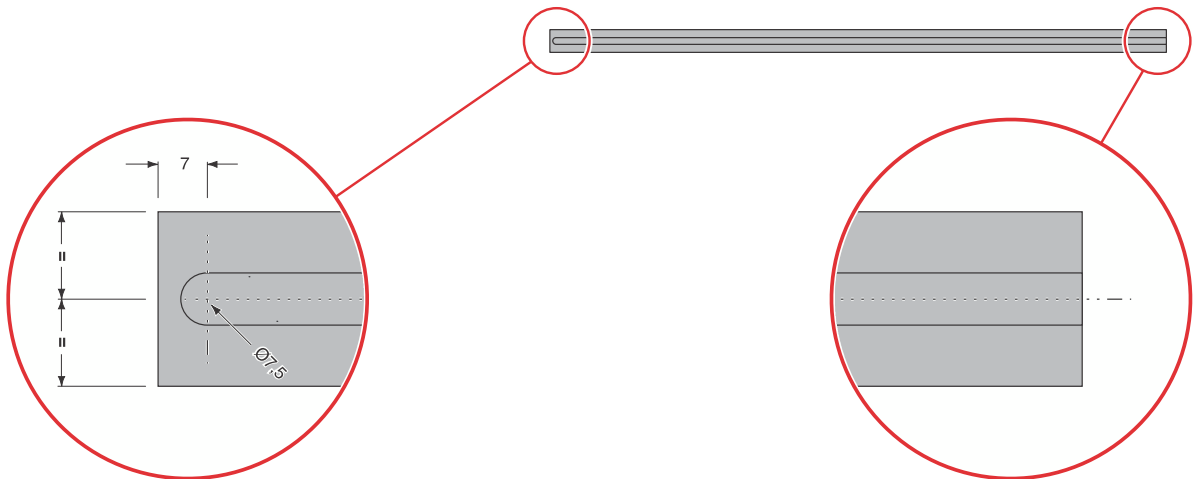
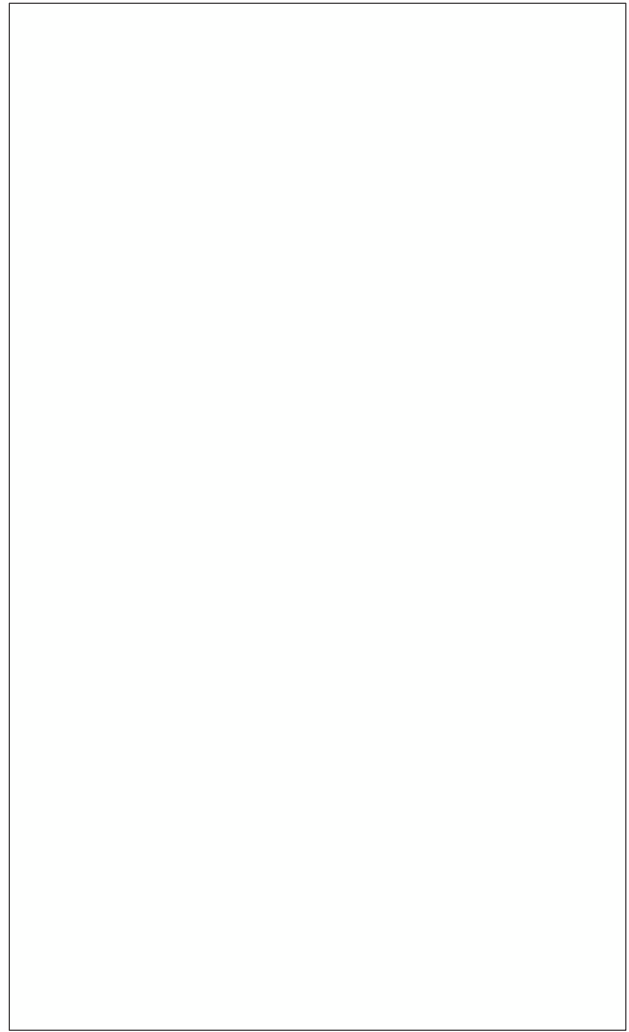
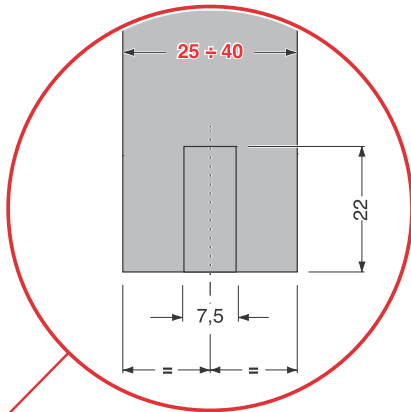
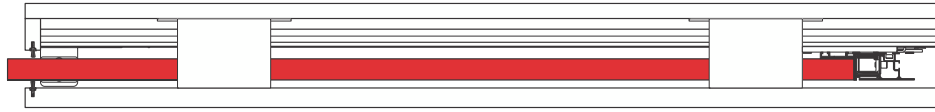

PS66 & B-moved

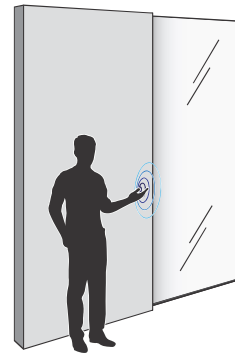
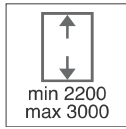

1

R

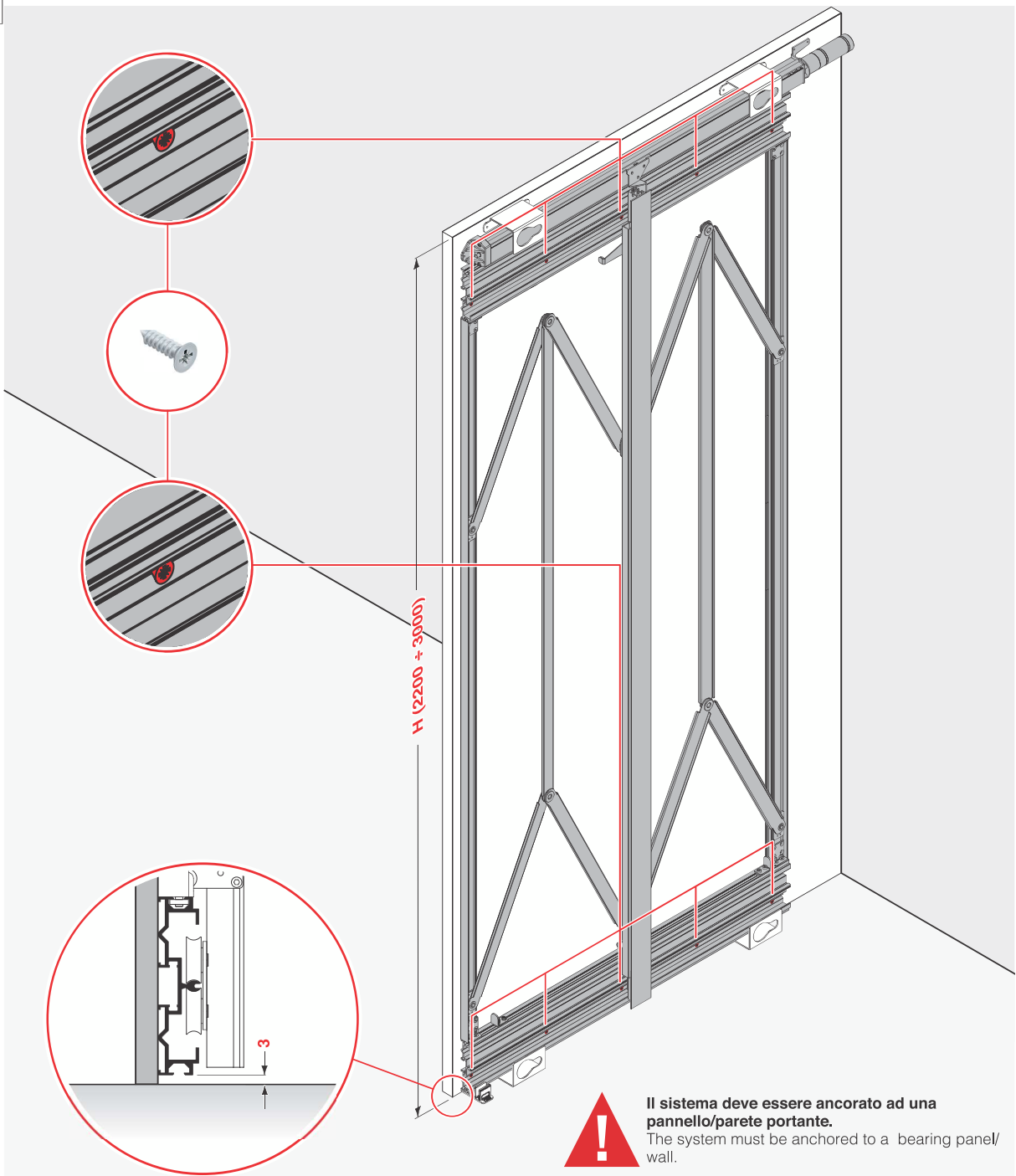
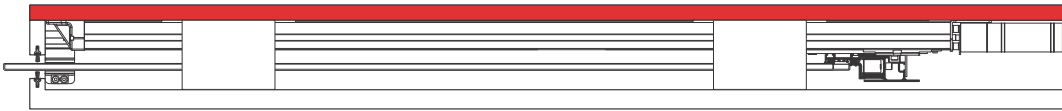

Il sistema deve essere ancorato ad una pannello/parete portante.
The system must be anchored to a bearing panel/wall.

R

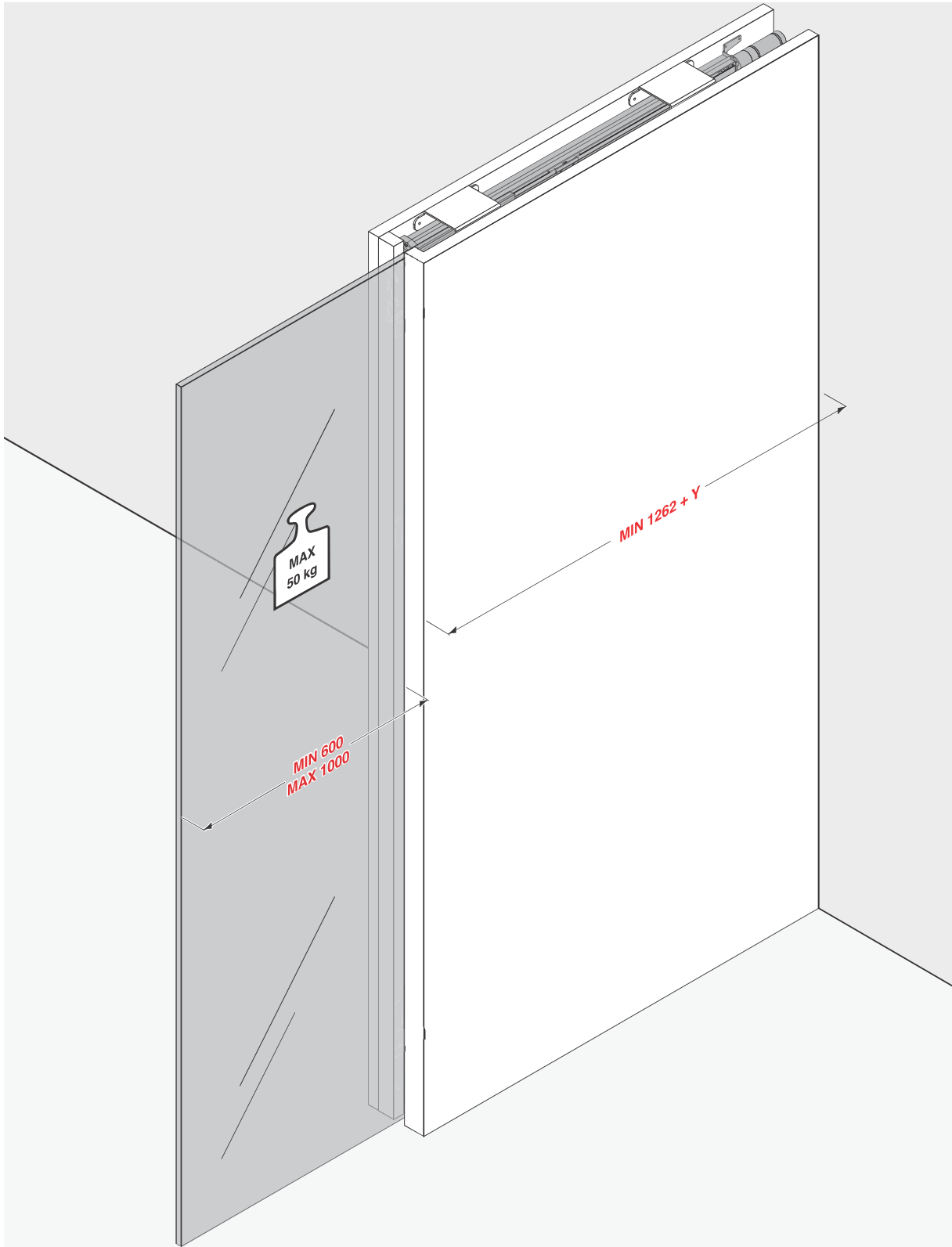
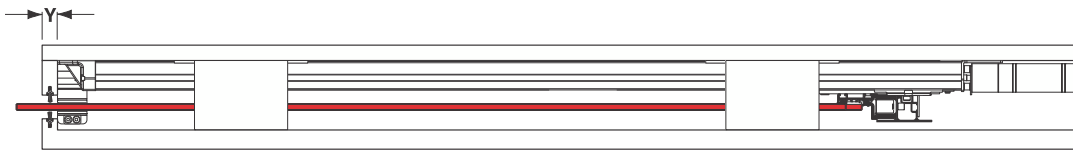

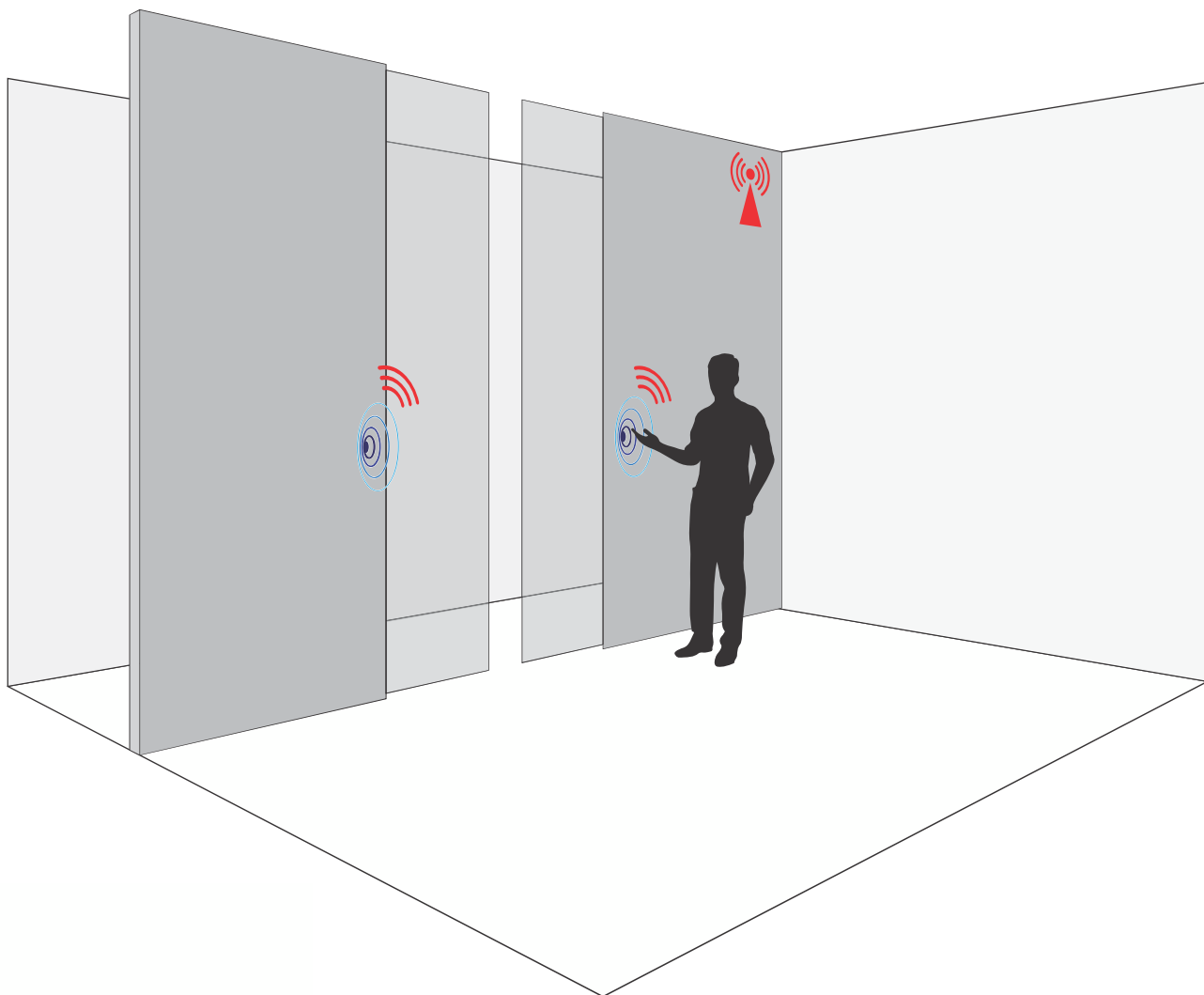



+

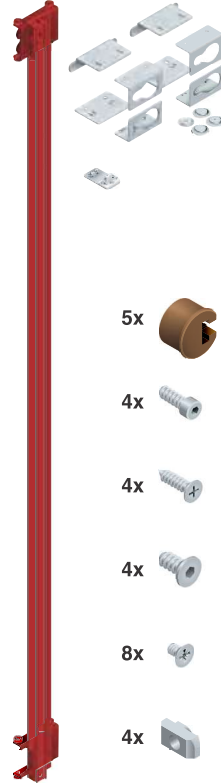

or

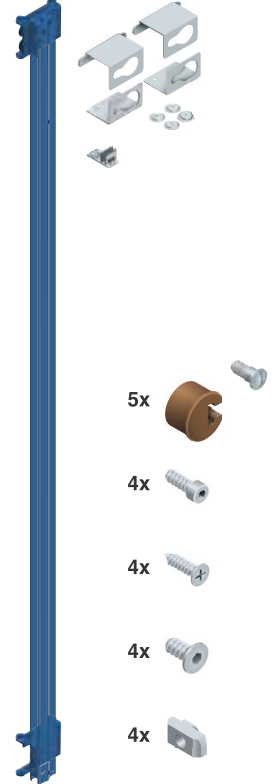

&

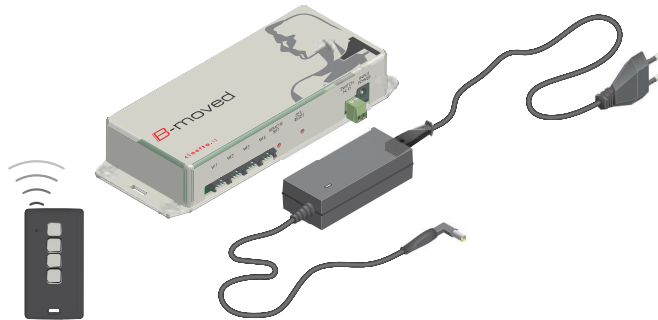

Lista componenti / Parts list

PS66MDSM70000001 H 2100÷2400

PS66MDSM70000002 H 2400÷2700

PS66MDSM70000003 H 2700÷3000

Meccanismo dx per porta scorrevole a scomparsa.
Finitura: Grezzo

Right system for concealed sliding door.
Finish: Raw



PS66MSSM70000001 H 2100÷2400

PS66MSSM70000002 H 2400÷2700

PS66MSSM70000003 H 2700÷3000

Meccanismo sx per porta scorrevole a scomparsa.
Finitura: Grezzo

Left system for concealed sliding door.
Finish: Raw



PS66. Lista componenti / Parts list

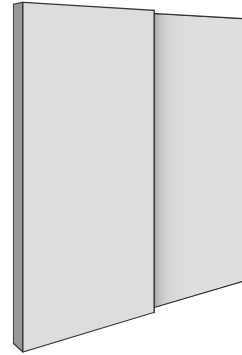

PS66PDLE70000001	H 2100÷2400
PS66PDLE70000002	H 2400÷2700
PS66PDLE70000003	H 2700÷3000

Confezione di montaggio per porta legno dx.
Finitura: Grezzo

Assembly kit for right wooden door.
Finish: Raw

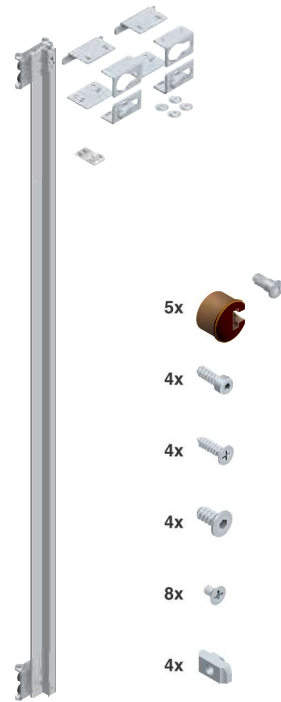

PS66PSLE70000001	H 2100÷2400
PS66PSLE70000002	H 2400÷2700
PS66PSLE70000003	H 2700÷3000

Confezione di montaggio per porta legno sx.
Finitura: Grezzo

Assembly kit for left wooden door.
Finish: Raw

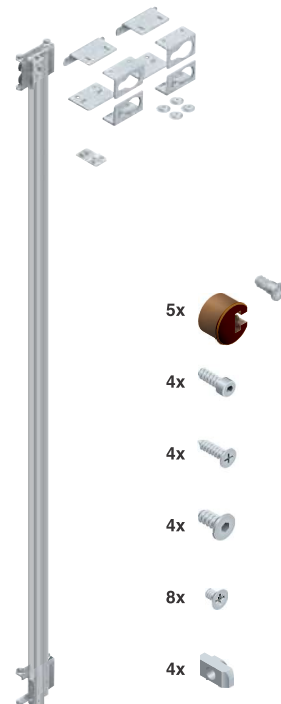

PS66. Lista componenti / Parts list

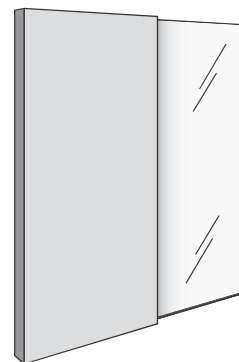
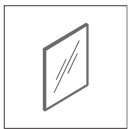

PS66PDVE70000001	H 2100÷2400
PS66PDVE70000002	H 2400÷2700
PS66PDVE70000003	H 2700÷3000

Confezione di montaggio per porta vetro dx.
 Finitura: Grezzo

Assembly kit for right glass door.
 Finish: Raw

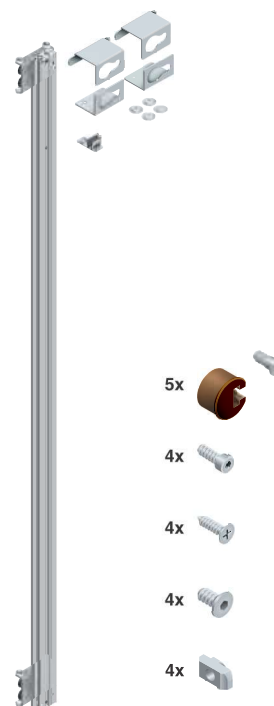

PS66PSVE70000001	H 2100÷2400
PS66PSVE70000002	H 2400÷2700
PS66PSVE70000003	H 2700÷3000

Confezione di montaggio per porta vetro sx.
 Finitura: Grezzo

Assembly kit for left glass door.
 Finish: Raw

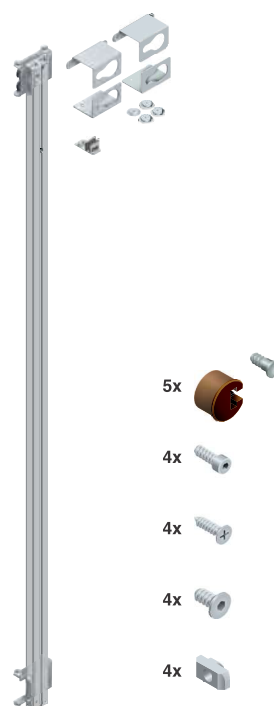

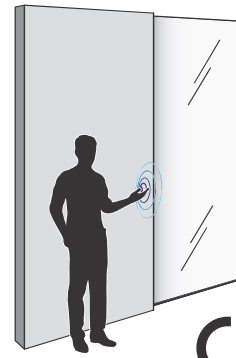

RAEE IT1901000011107

PS66KE70020001

Confezione sistema B-moved per porta dx.
Finitura: Anodizzato argento chimico

B-moved system kit for right door.
Finish: Chemical silver anodized



PS66KE70020002

Confezione sistema B-moved per porta sx.
Finitura: Anodizzato argento chimico

B-moved system kit for left door.
Finish: Chemical silver anodized



BM01CE8B000007

Unità di controllo elettronico con telecomando per sistema PS66 & B-moved.

Electronic unit control with remote control for PS66 & B-moved system.



BM01SE8B000002

Unità ricevente Wave Sensor.

Wave Sensor receiver unit.



PS66. Lista componenti / Parts list

BM01CO90000001

Connettore per ingresso ausiliario di controllo.
Finitura: Nero

Connector for auxiliary control input.
Finish: Black

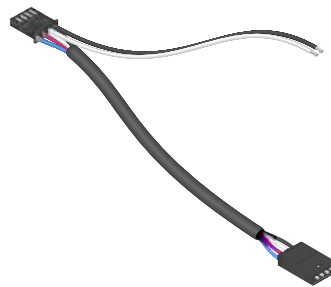

BM01SE90000001

Wave Sensor con adattatore per il montaggio. Batterie non incluse.
Finitura: Nero

Wave Sensor with assembling accessory. Batteries not included.
Finish: Black

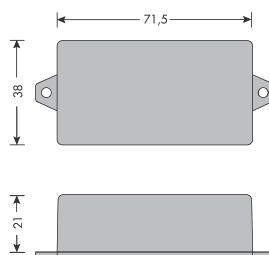
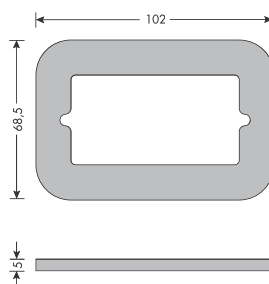



Non utilizzare spray ed oli anti frizione o sblocca filetti sui cuscinetti o sulle ruote con O-ring dei pattini scorrevoli. Questo provoca lo scioglimento dei grassi dei cuscinetti rendendoli rumorosi oppure la rottura dell'O-ring.

Do not use any anti-friction oil or grease or thread-relese spray on ball bearing or on wheels with O-ring, it can cause the melting of the inside ball bearing grease, making them noisy or causing the break of the O-ring of the wheels.

Tutte le parti del catalogo sono di proprietà della Cinetto F.Ili S.r.l.

È vietata qualsiasi imitazione e copia delle illustrazioni, della grafica e la riproduzione, anche parziale, del presente catalogo senza autorizzazione.

I disegni tecnici e le informazioni dimensionali, incluse le illustrazioni, riportate in questo catalogo non sono vincolanti. L'azienda si riserva il diritto di apportare modifiche a fini migliorativi. Tutte le dimensioni sono in mm, se non diversamente specificate.

Si declina ogni responsabilità per errori di stampa.

All constituents of the catalogue are the property of Cinetto F.Ili S.r.l.

Reprint of the catalogue or extracts thereof, reprinting or imitation of the illustrations or drawings is forbidden without permission.

The technical representations and dimensional information in this catalogue are non-binding, including those in the illustrations and drawings. Right reserved to make design improvements. All dimensions are in mm unless otherwise specified.

No liability accepted for printing errors of the catalogue.

Rilasciato da - Issued by
Cinetto F.Ili S.r.l.
Via Meucci, 4 - 35030 Rubano (PD) Italy

Tel. +39 049 8977211 - Fax +39 049 635822

Internet: www.cinetto.it - Email: info@cinetto.it

Gennaio 2021
© by Cinetto F.Ili S.r.l.
All rights reserved.
Printed in Padova - Italy



Sede Legale e Officina di Produzione

Via Meucci, 4 - 35030 Rubano (PD) Italy

www.cinetto.it - info@cinetto.it

Sede Amministrativa, Magazzino e Punto Vendita

Via Rossi, 5/A - 35030 Rubano (PD) Italy
Tel. +39 049 8977211 - Fax +39 049 635822
C.F./P.I. (VAT) (IT) 00277120283

