



# PS23

**Sistema scorrevole  
per ante a libro**

Sliding system for  
folding doors





# PS23

**Sistema scorrevole per ante a libro**  
Sliding system for folding doors

**Accessori complementari**  
Additional accessories

- **PR20 - Ante in alluminio.**  
PR20 - Aluminium doors
- **BR - Raddrizza ante.**  
BR - Doors Straightener.

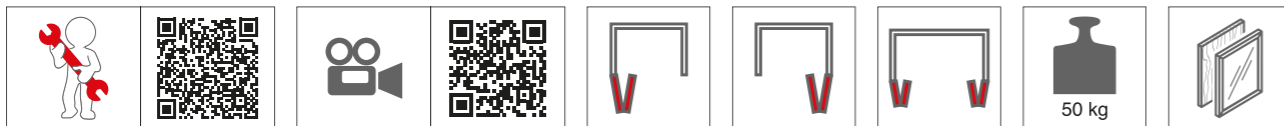

# PS23, la semplicità è la chiave per il successo.

PS23, simplicity is the key to success.

■ PS23 - 25

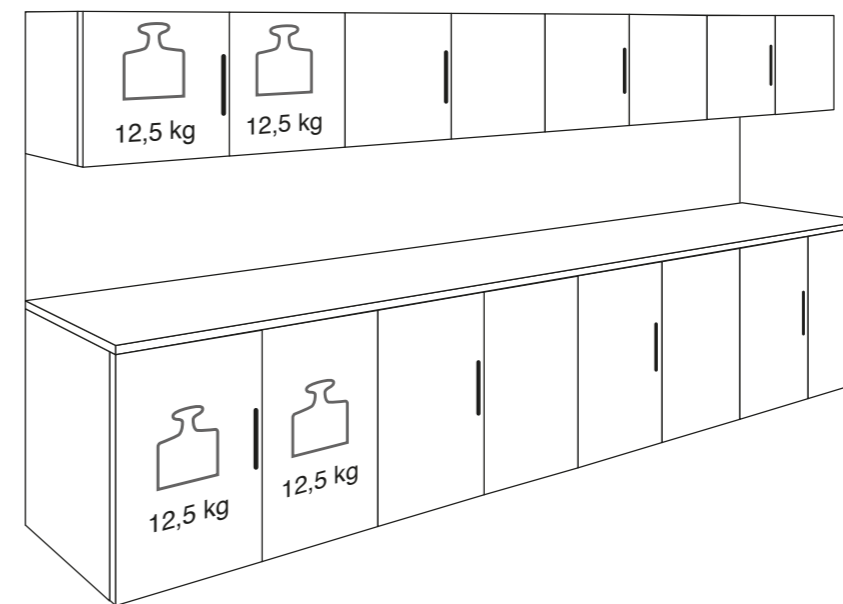

■ PS23 - 50

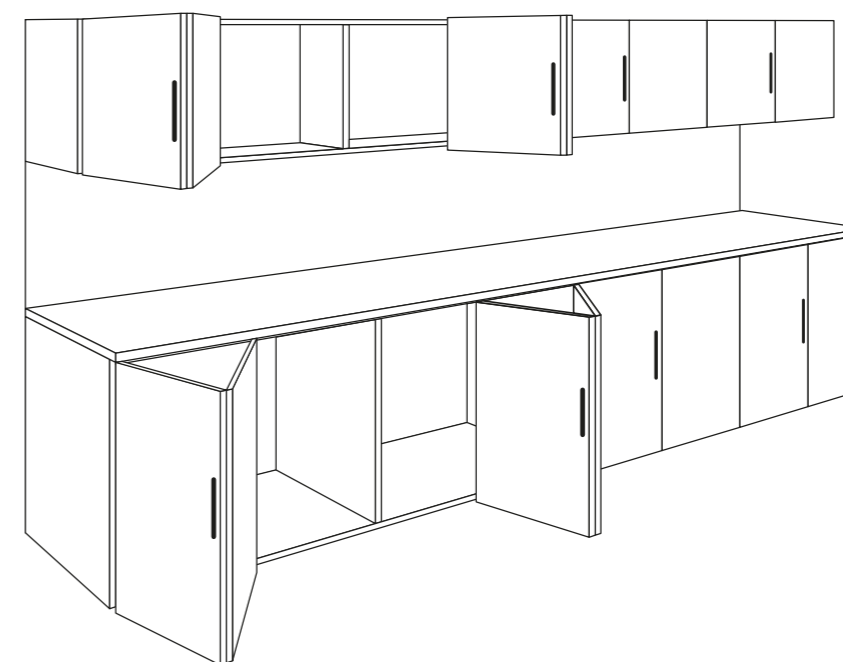
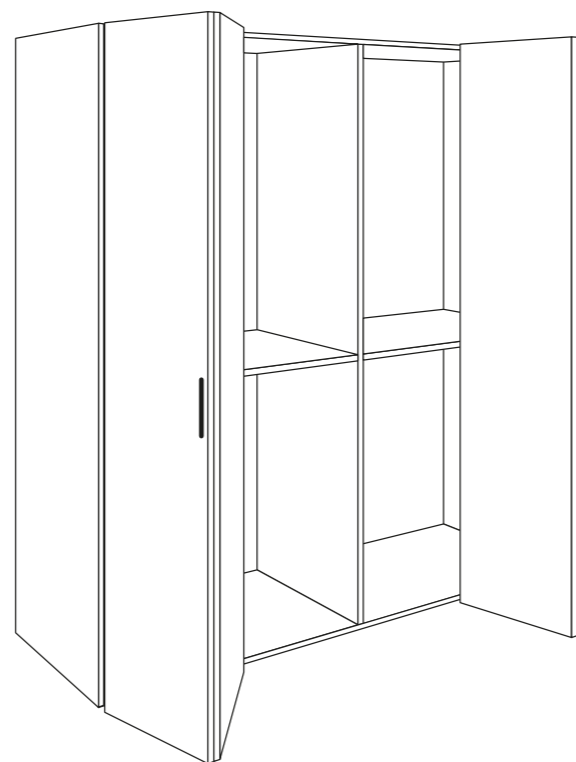
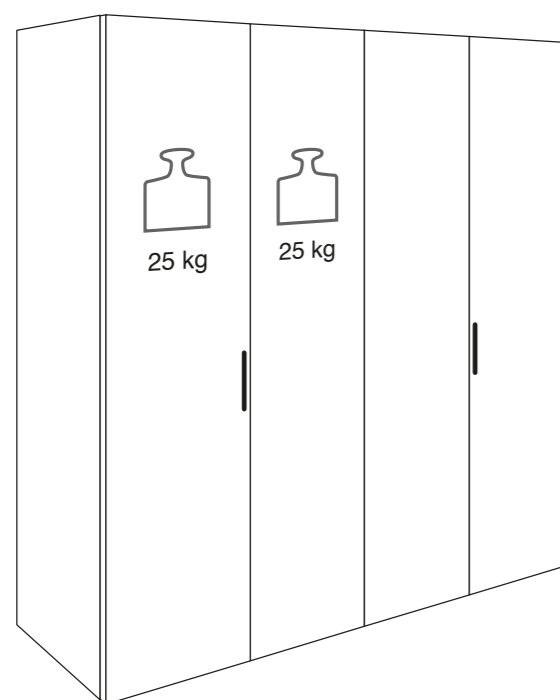

# PS23

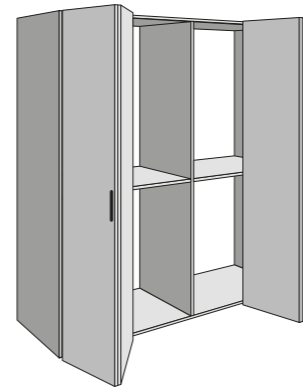

■ **Cerniere laterali standard.**  
Standard side hinges.

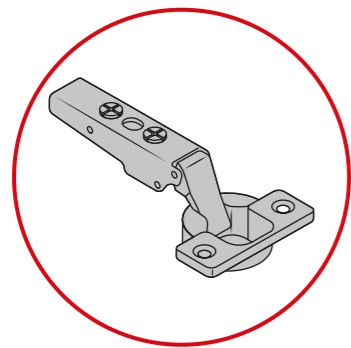
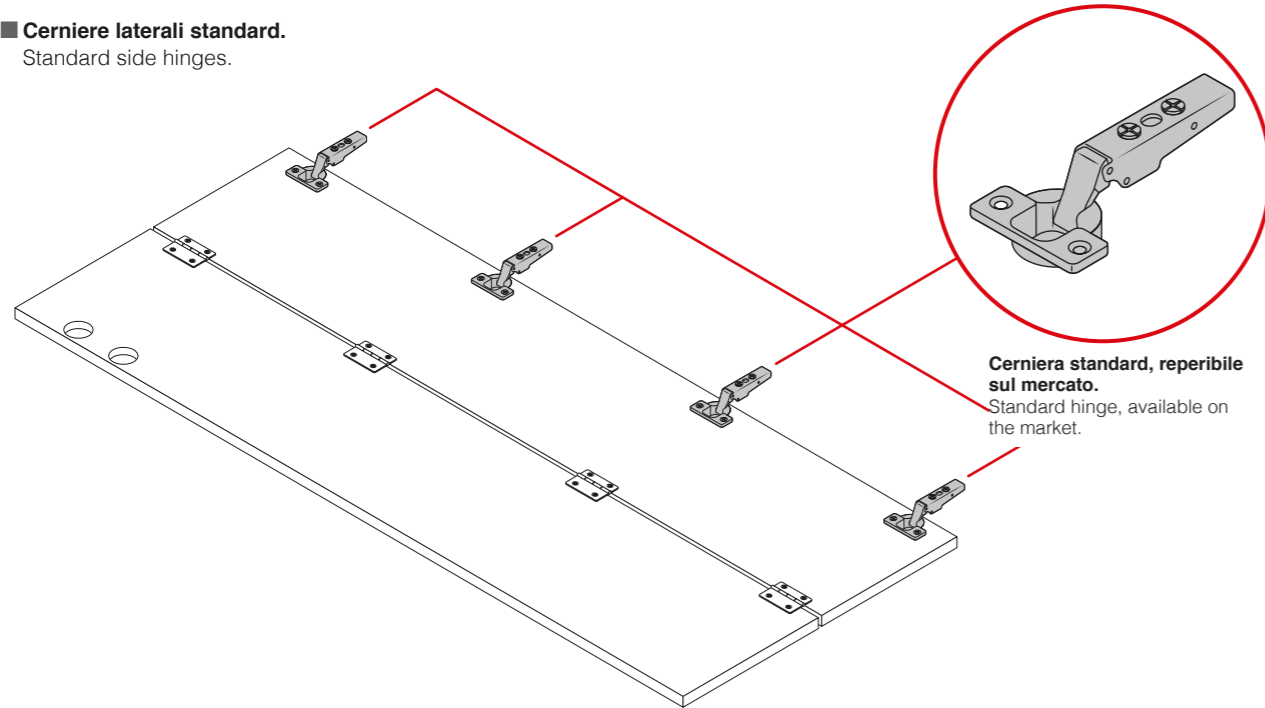

**SOFT-CLOSING**  
L'effetto "soft-closing" si ottiene usando cerniere ammortizzate.  
SOFT-CLOSING  
"Soft-closing" effect simply using "soft-closing" hinges.

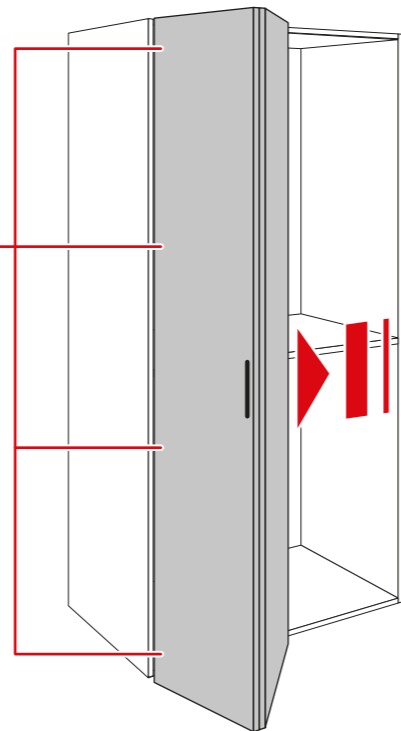

PS23. Schede tecniche / Data sheets

■ **Massima stabilità.**  
Maximum stability.

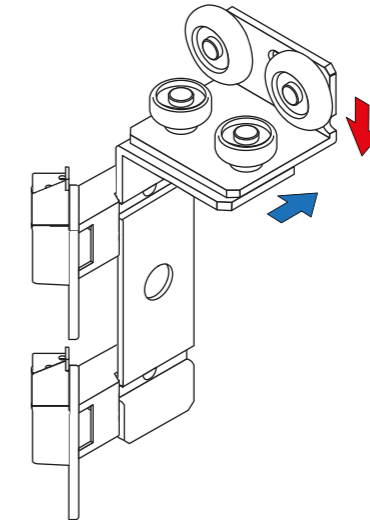
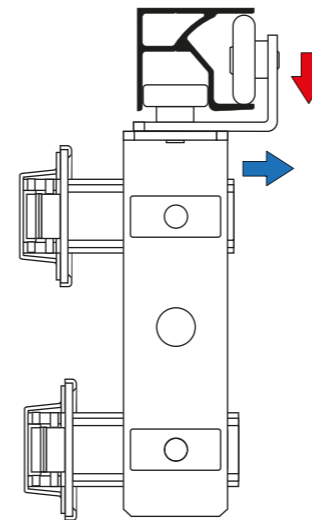

↓ **Forza verticale**  
Vertical force  
→ **Forza orizzontale**  
Horizontal force

■ **Cover.**  
Cover.

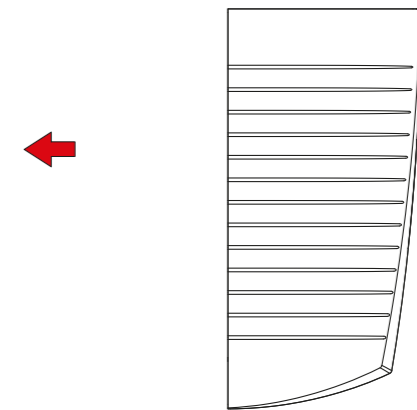
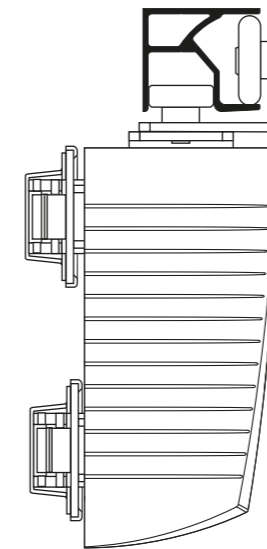

# PS23 - 50

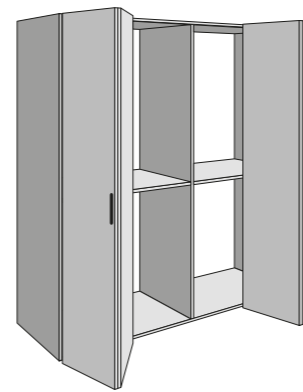
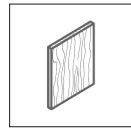

■ **Senza binario inferiore.**  
Without lower rail.

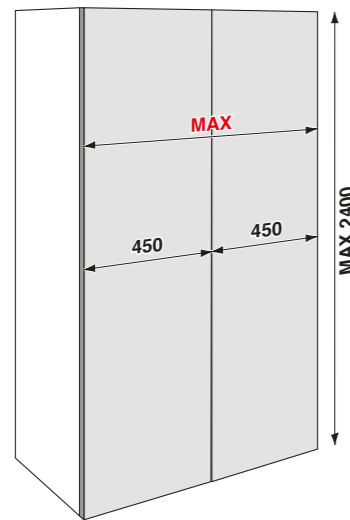

■ **Con binario inferiore.**  
With lower rail.

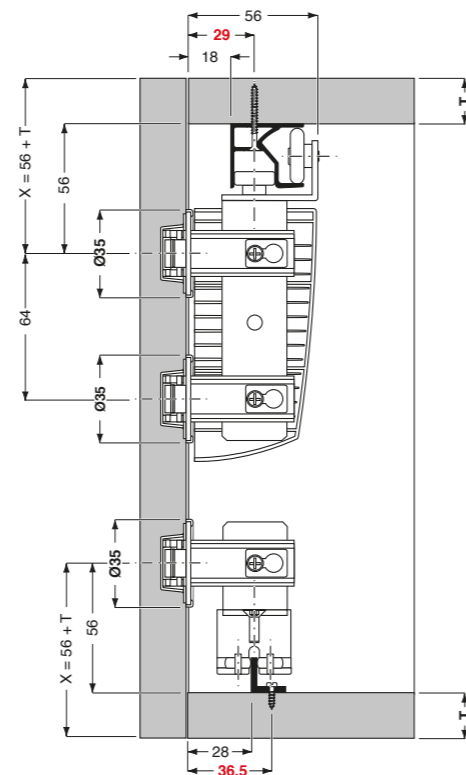
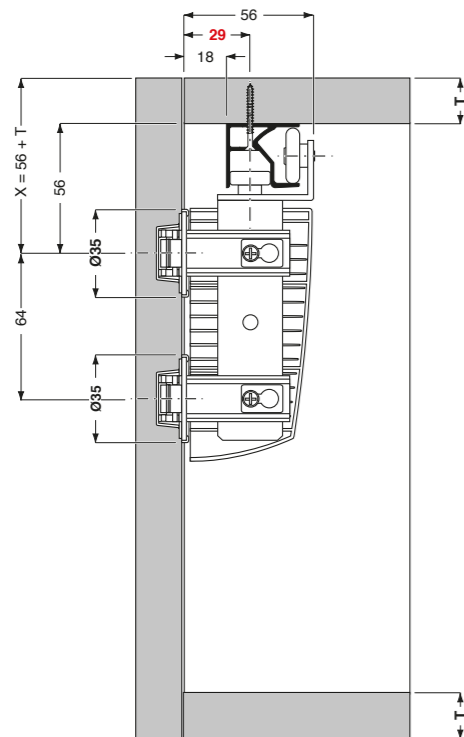
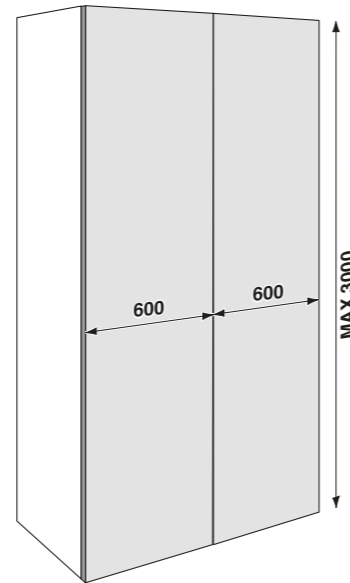

## PS23. Schede tecniche / Data sheets

■ **Cerniere centrali standard.**  
Standard central hinges.

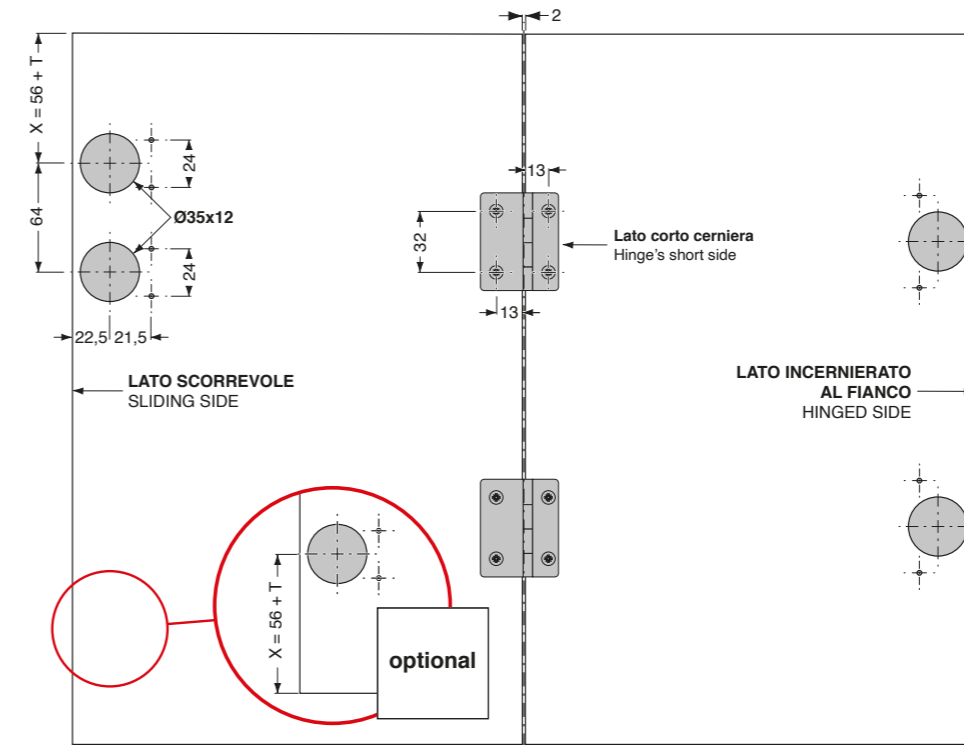

option  
**1**

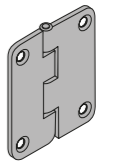

**CL01105042**

ABBREVIAZIONI:  
T = spessore fondo/cappello  
ABBREVIATIONS:  
T = top / bottom panel thickness

■ **Cerniere centrali regolabili.**  
Adjustable central hinges.

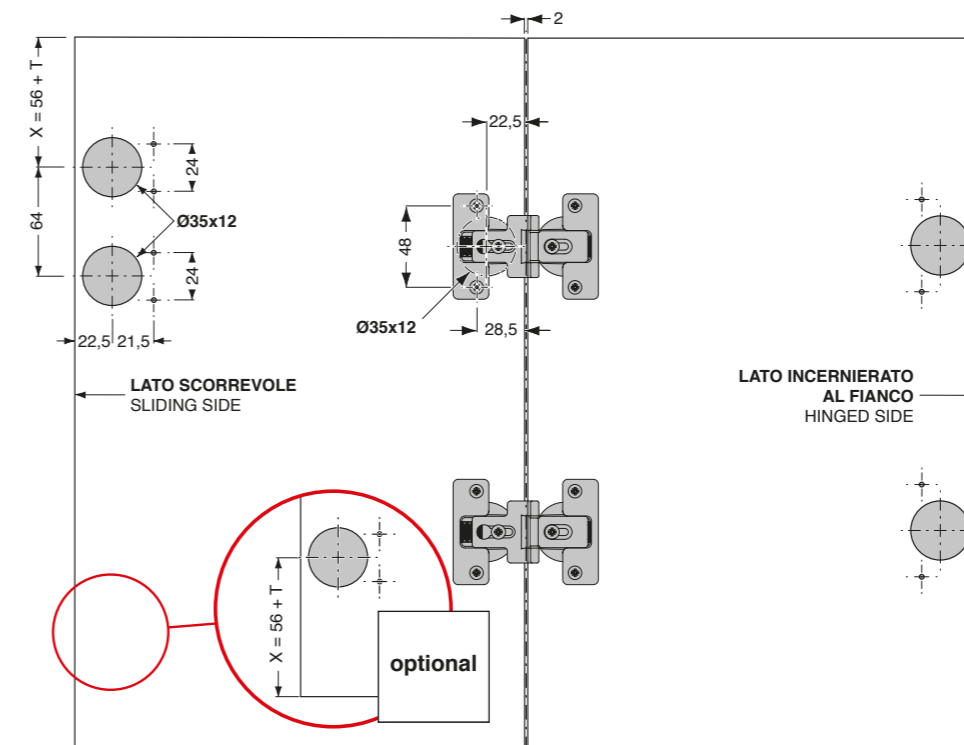

option  
**2**

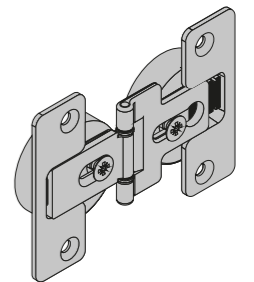

**CL01420035**

# PS23 - 25

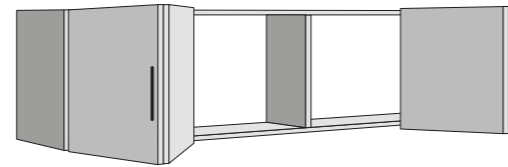
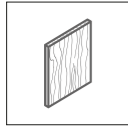

■ **Senza binario inferiore.**  
Without lower rail.

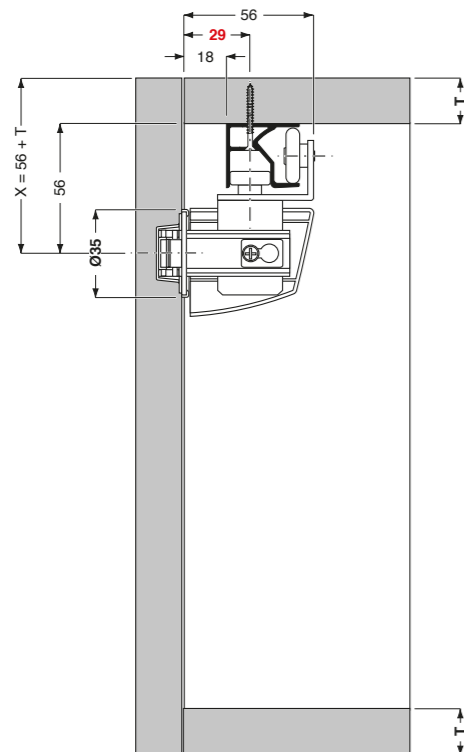
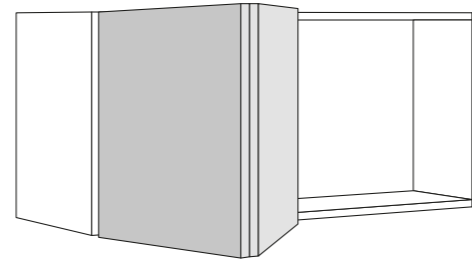
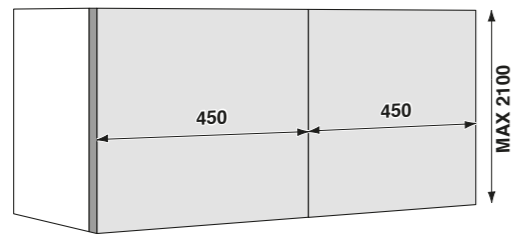

**!** **Rispettare rigorosamente i limiti di peso.**  
Carefully respect the weight limit.

## PS23. Schede tecniche / Data sheets

■ **Cerniere centrali standard.**  
Standard central hinges.

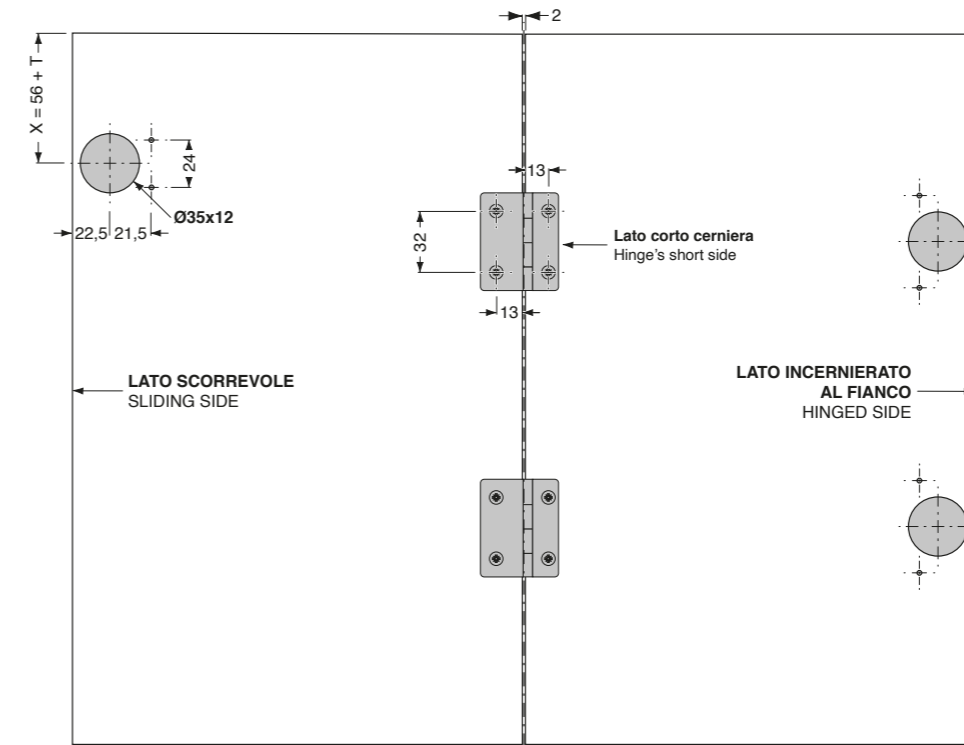

option  
**1**

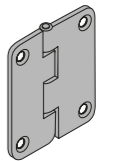

**CL01105042**

ABBREVIAZIONI:  
T = spessore fondo/cappello  
ABBREVIATIONS:  
T = top / bottom panel thickness

■ **Cerniere centrali regolabili.**  
Adjustable central hinges.

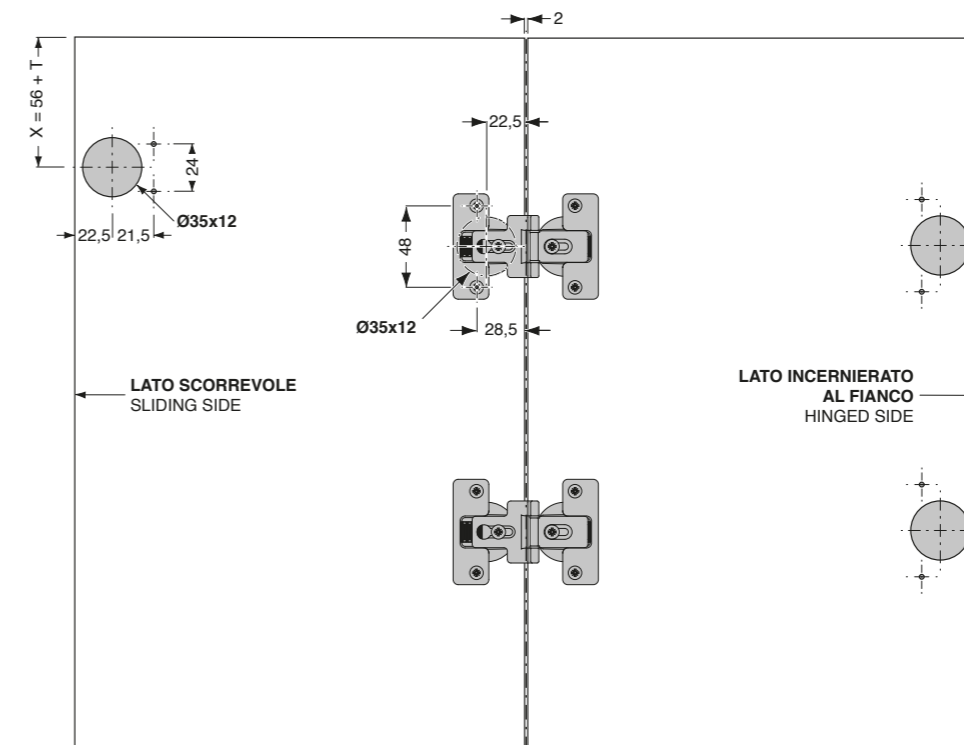

option  
**2**

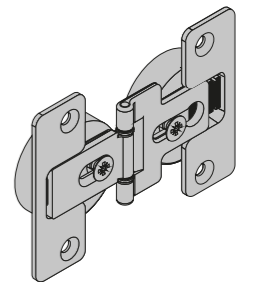

**CL01420035**

# PS23

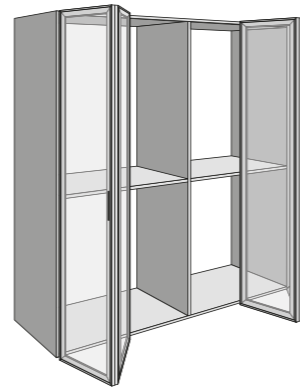
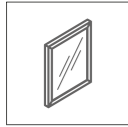

## PS23 - 50

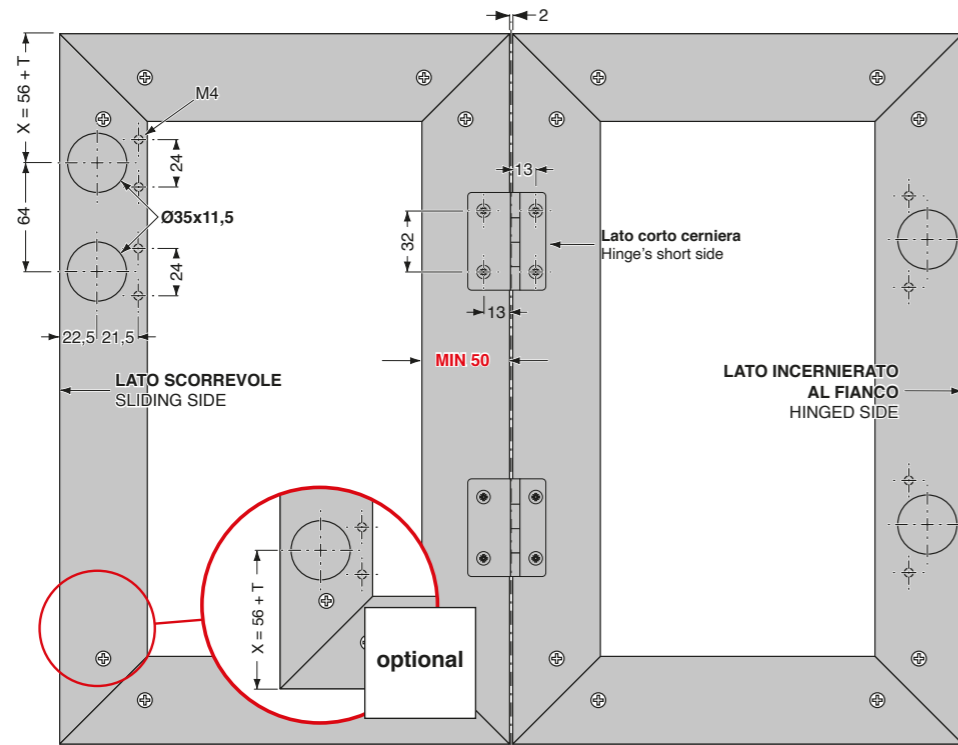

## PS23 - 25

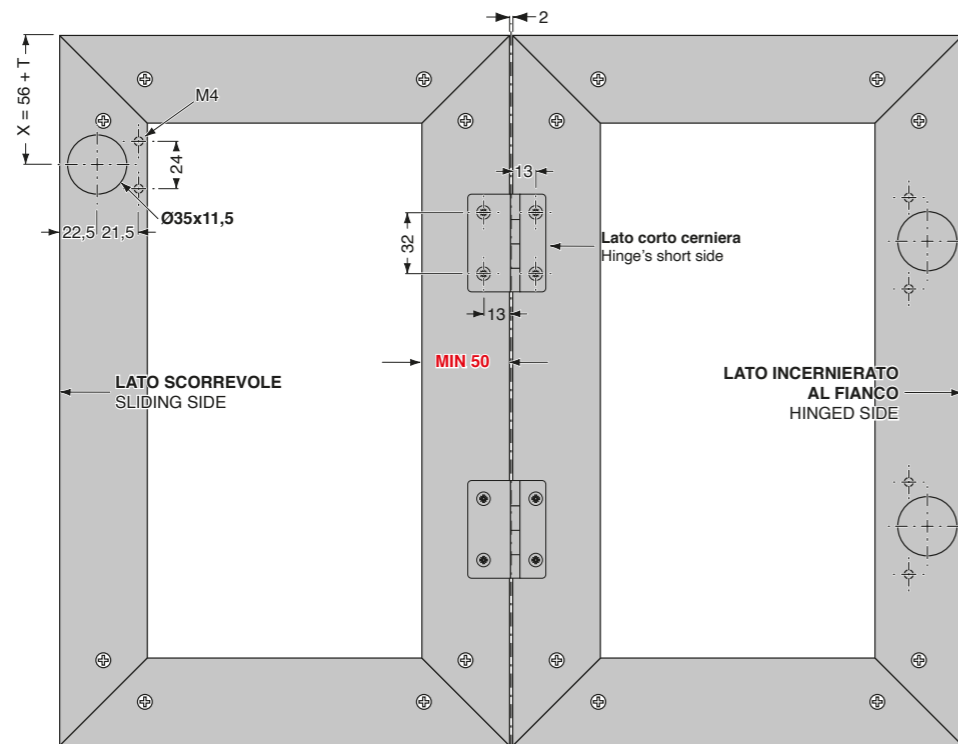

## PS23. Schede tecniche / Data sheets

1

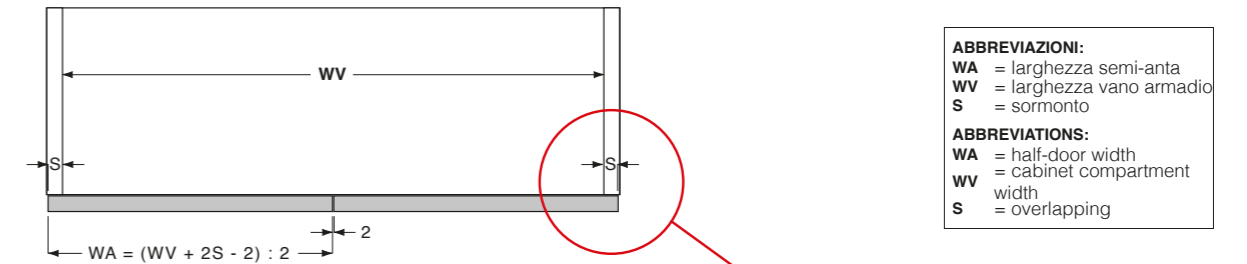

**ABBREVIAZIONI:**  
**WA** = larghezza semi-anta  
**WV** = larghezza vano armadio  
**S** = sormonto

**ABBREVIATIONS:**  
**WA** = half-door width  
**WV** = cabinet compartment width  
**S** = overlapping

60 + spessore ante  
 60 + doors thickness

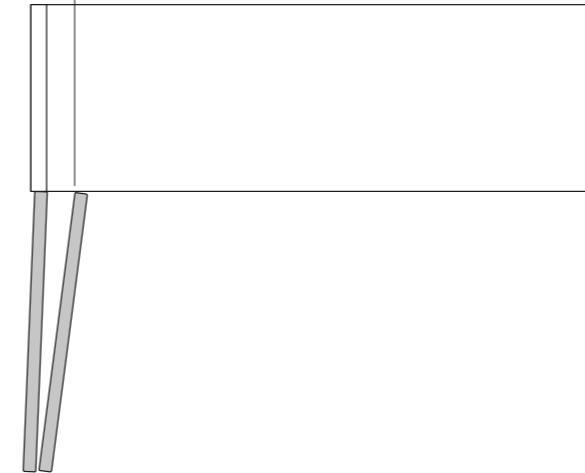

2

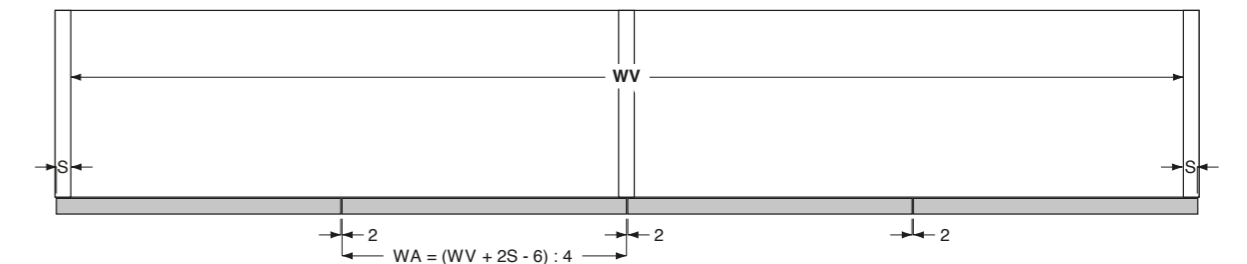

60 + spessore ante  
 60 + doors thickness

60 + spessore ante  
 60 + doors thickness

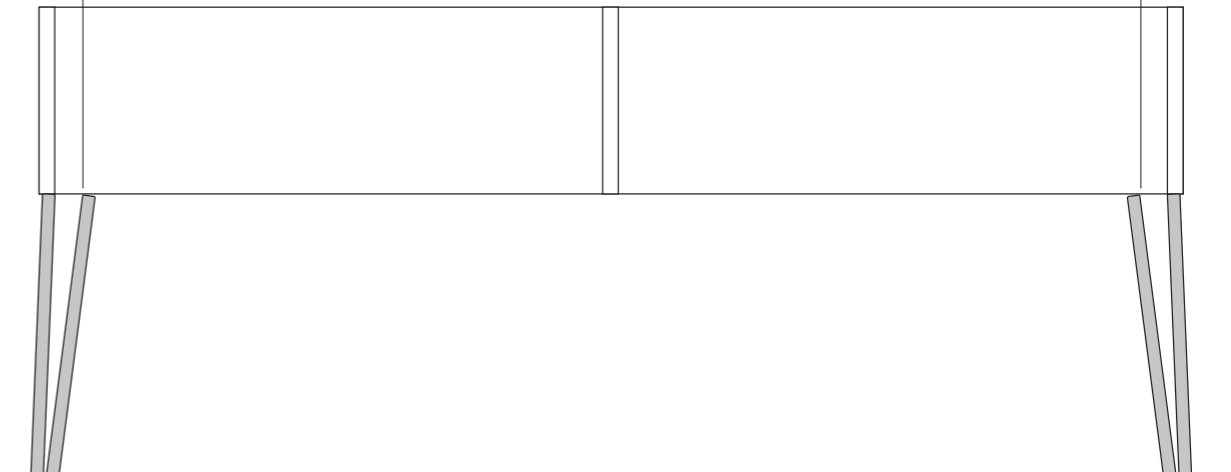

# Lista componenti / Parts list

## PS23 - 50

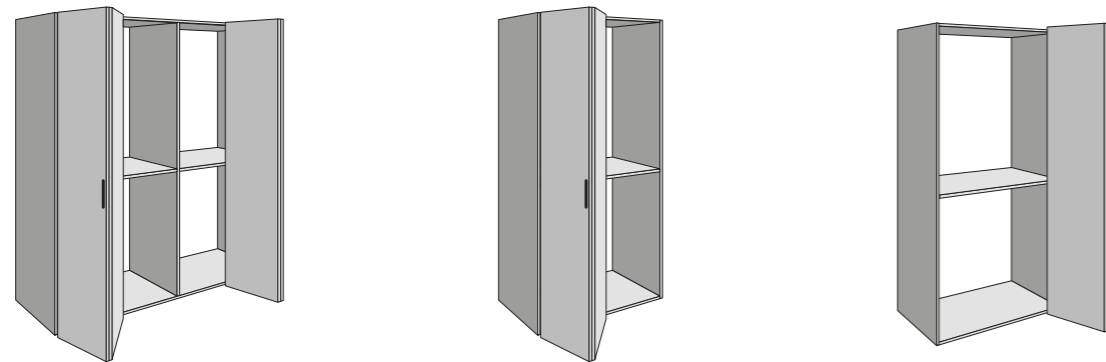

### PR2370001A

Binario superiore.

Upper rail.

**Finiture standard / standard finishes**  
Anodizzato / anodized: Silver

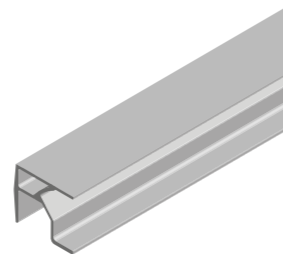
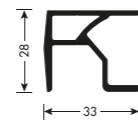
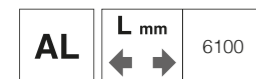

### PS23KS1001

Confezione pattino superiore.  
Finitura: Zincato

Kit of upper slide.  
Finish: Zinc plated

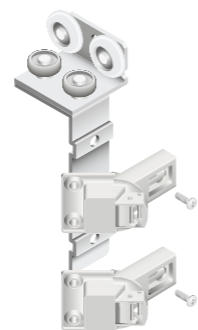

### PS23KS1002

Confezione pattino superiore.  
Finitura: Zincato

Kit of upper slide.  
Finish: Zinc plated

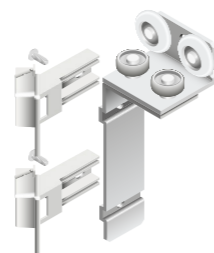

## PS23. Lista componenti / Parts list

### PS23CO8E01

Scatola copricerniere.  
Finitura: Grigio metallizzato

Plastic cover.  
Finish: Metalized grey

PL

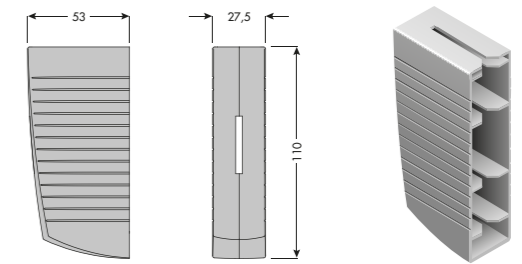

### CL01105042

Cerniera asimmetrica.  
Finitura: Zincato

Asymmetric hinge.  
Finish: Zinc plated

option 1 FE

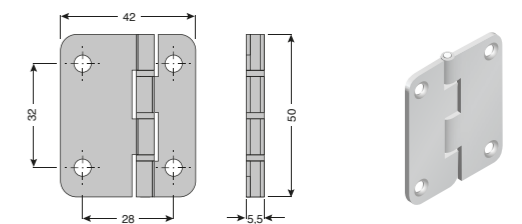

### CL01420035

Cerniera centrale regolabile.  
Finitura: Nichelato satinato

Adjustable central hinge.  
Finish: Satin nickel

option 2



### PR557015150020

Binario inferiore.

Lower rail.

**Finiture standard / standard finishes**  
Anodizzato / anodized: Silver

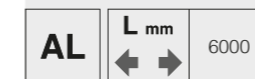

### PS23KI1001

Confezione pattino inferiore.  
Finitura: Grigio

Kit of lower slide.  
Finish: Grey

PL

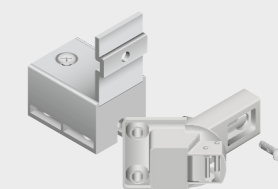



# PS23 - 25

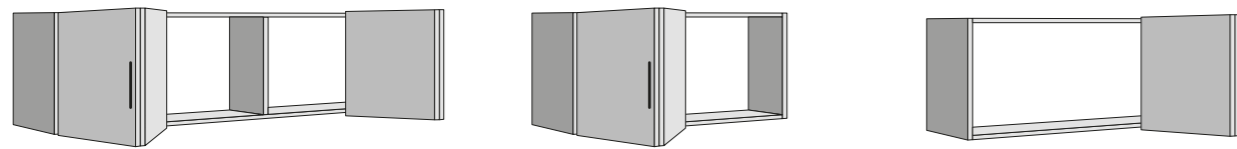

## PR2370001A

Binario superiore.

Upper rail.

**Finiture standard / standard finishes**  
Anodizzato / anodized: Silver

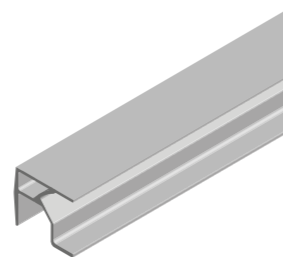
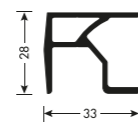

## PS23KS1003

Confezione pattino superiore.  
Finitura: Zincato

Kit of upper slide.  
Finish: Zinc plated

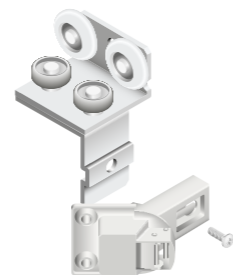

## PS23KS1004

Confezione pattino superiore.  
Finitura: Zincato

Kit of upper slide.  
Finish: Zinc plated

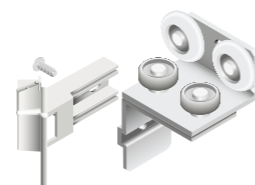

## PS23CO8E04

Scatola copricerniera.  
Finitura: Grigio metallizzato

Plastic cover.  
Finish: Metalized grey

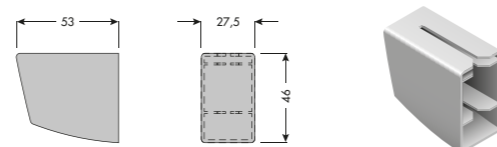

## PS23. Lista componenti / Parts list

### CL01105042

Cerniera asimmetrica.  
Finitura: Zincato

Asymmetric hinge.  
Finish: Zinc plated

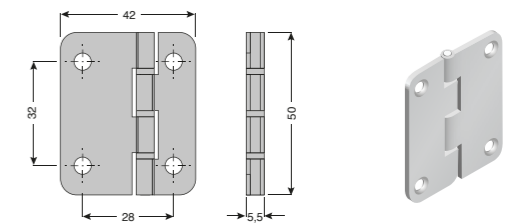

### CL01420035

Cerniera centrale regolabile.  
Finitura: Nichelato satinato

Adjustable central hinge.  
Finish: Satin nickel



## Accessori complementari Additional accessories

### BR

Raddrizza ante.

Doors straightener.

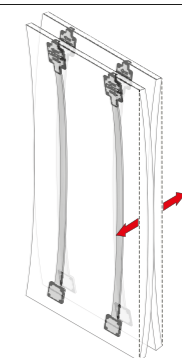

### PR20

Ante in alluminio.

Aluminium doors.





**Non utilizzare spray ed oli anti frizione o sblocca filetti sui cuscinetti o sulle ruote con O-ring dei pattini scorrevoli. Questo provoca lo scioglimento dei grassi dei cuscinetti rendendoli rumorosi oppure la rottura dell'O-ring.**  
Do not use any anti-friction oil or grease or thread-release spray on ball bearing or on wheels with O-ring, it can cause the melting of the inside ball bearing grease, making them noisy or causing the break of the O-ring of the wheels.

Tutte le parti del catalogo sono di proprietà della Cinetto F.Ili S.r.l.

È vietata qualsiasi imitazione e copia delle illustrazioni, della grafica e la riproduzione, anche parziale, del presente catalogo senza autorizzazione.

I disegni tecnici e le informazioni dimensionali, incluse le illustrazioni, riportate in questo catalogo non sono vincolanti. L'azienda si riserva il diritto di apportare modifiche a fini migliorativi.  
Tutte le dimensioni sono in mm, se non diversamente specificate.

Si declina ogni responsabilità per errori di stampa.

All constituents of the catalogue are the property of Cinetto F.Ili S.r.l.

Reprint of the catalogue or extracts thereof, including those in the illustrations and imitation of the design is forbidden without permission.

The technical representations and dimensional information in this catalogue are non-binding, including those in the illustrations and drawings. Right reserved to make design improvements.  
All dimensions are in mm unless otherwise specified.

No liability accepted for printing errors of the catalogue.

Rilasciato da - Issued by  
Cinetto F.Ili S.r.l.  
Via Meucci, 4 - 35030 Rubano (PD) Italy

Tel. +39 049 8977211 - Fax +39 049 635822

Internet: [www.cinetto.it](http://www.cinetto.it) - Email: [info@cinetto.it](mailto:info@cinetto.it)

Ottobre 2021  
© by Cinetto F.Ili S.r.l.  
All rights reserved.  
Printed in Padova - Italy



**Sede Legale e Officina di Produzione**

Via Meucci, 4 - 35030 Rubano (PD) Italy

[www.cinetto.it](http://www.cinetto.it) - [info@cinetto.it](mailto:info@cinetto.it)

**Sede Amministrativa, Magazzino e Punto Vendita**

Via Rossi, 5/A - 35030 Rubano (PD) Italy  
Tel. +39 049 8977211 - Fax +39 049 635822  
C.F./P.I. (VAT) (IT) 00277120283

