

# SELF-OPENING STAY



## HDS-20S



### Features

- Opens automatically if flap is pulled open slightly.
- Built-in damper causes flap to open gently, preventing slamming.
- Built-in catch to hold flap when fully closed.
- Can also be used with single axis hinges like concealed, piano or butt hinges.

### Applicable Range

Torque Moment	Model	Qty
6.9 - 10.8 N·m	H	1 pair
10.9 - 14.7 N·m	S	1 pair

### Remarks

Used in pairs.

### Parts Included

- Mounting plate
- Binding tapping screw 3.5x15

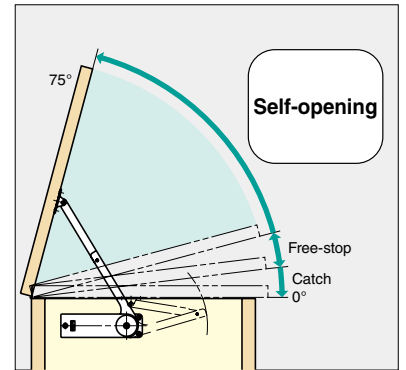
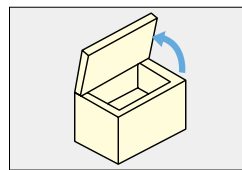

### Application Example

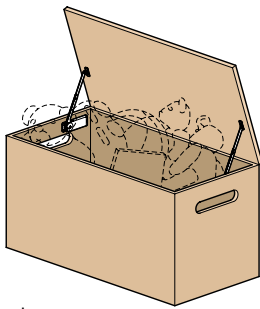

Toy boxes

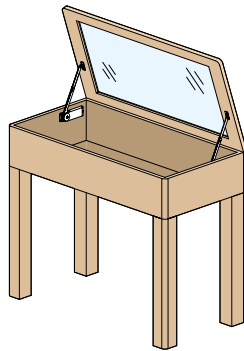

Display cabinets

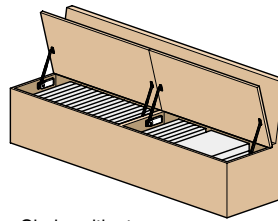

Chairs with storage

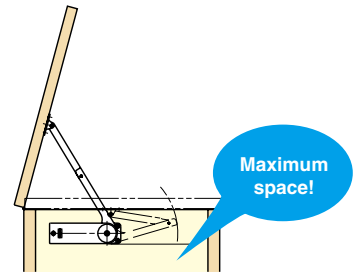

### Installation

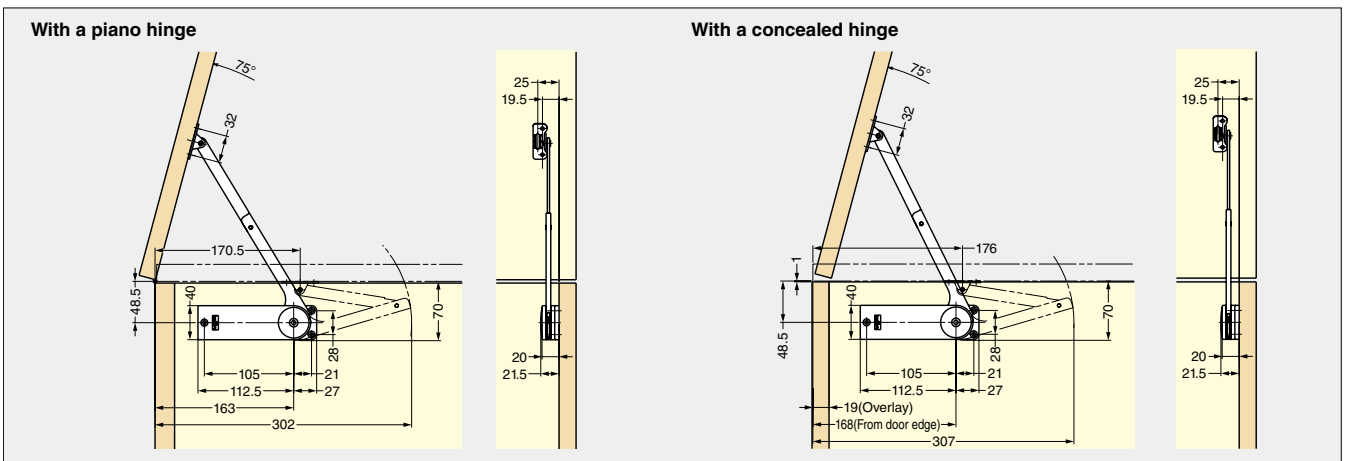

Item Code	Item Name	Type	Material	Finish/Colour	Model	Torque Moment/pair	Weight	Carton
180-029-751	HDS-20S-HL-BL	Left	ABS/Steel	Nickel/Black	H	6.9 - 10.8 N·m (70 - 110 kgf·cm)	298 g	40 pcs
180-029-752	HDS-20S-HR-BL	Right		Nickel/White				
180-029-753	HDS-20S-HL-WT	Left		Nickel/Black	S	10.9 - 14.7 N·m (111 - 150 kgf·cm)	311 g	40 pcs
180-029-754	HDS-20S-HR-WT	Right		Nickel/White				
180-029-755	HDS-20S-SL-BL	Left						
180-029-756	HDS-20S-SR-BL	Right						
180-029-757	HDS-20S-SL-WT	Left						
180-029-758	HDS-20S-SR-WT	Right						